

Safety Instructions



0,1,2,4,6,7,8,9,11,
15,18,20,22,25,27



Info Hotline

+49 (0) 5041 998 389

Mon.-Do. 7⁰⁰-20⁰⁰

Fr. 7⁰⁰-17⁰⁰

Paulmann Licht GmbH
31832 Springe / Germany
www.paulmann.com

Art.-Nr.:
60138
60150

(+MA 173)

PDG 04/11

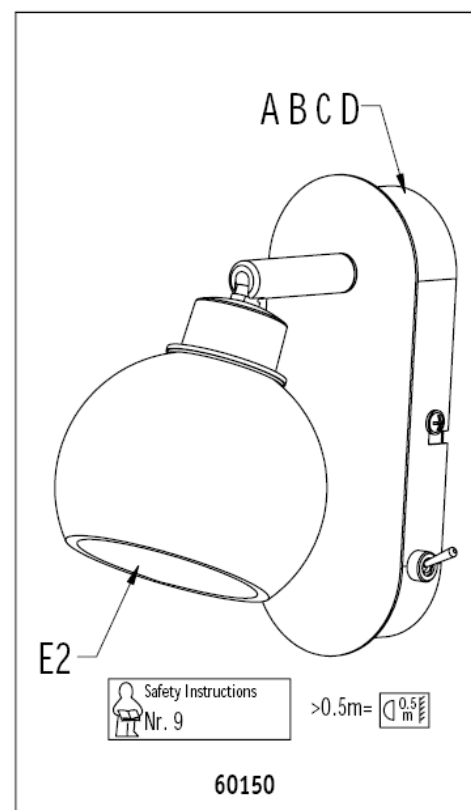
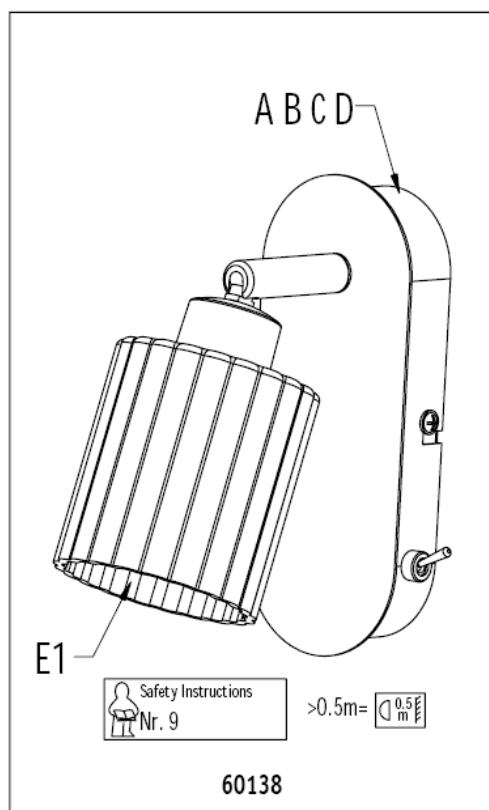
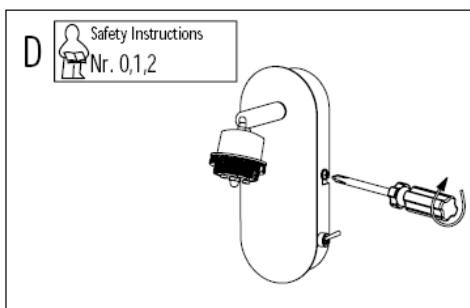
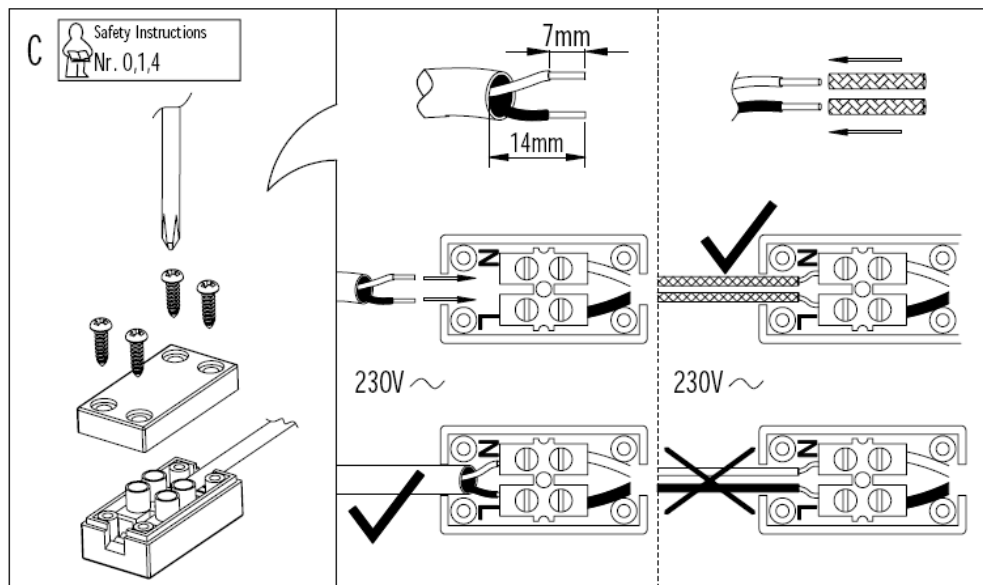
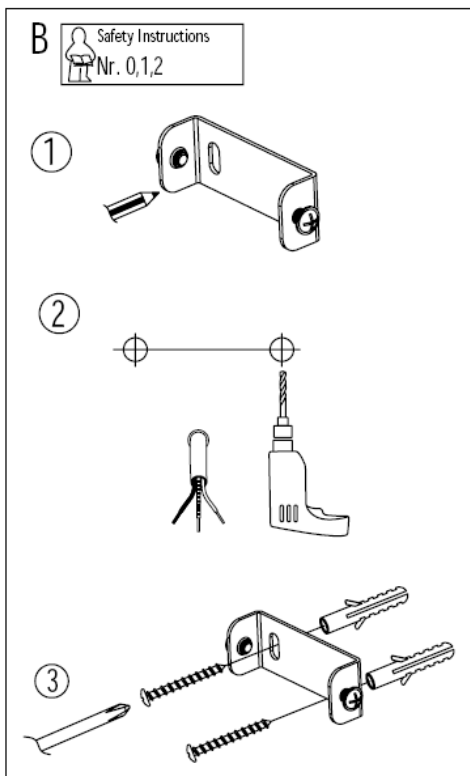
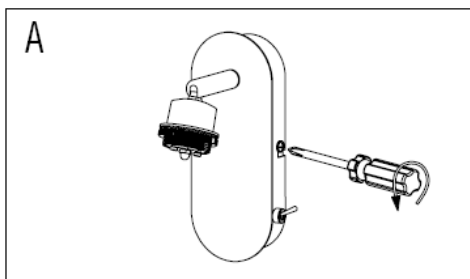
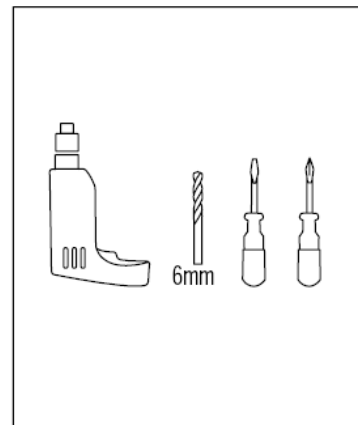
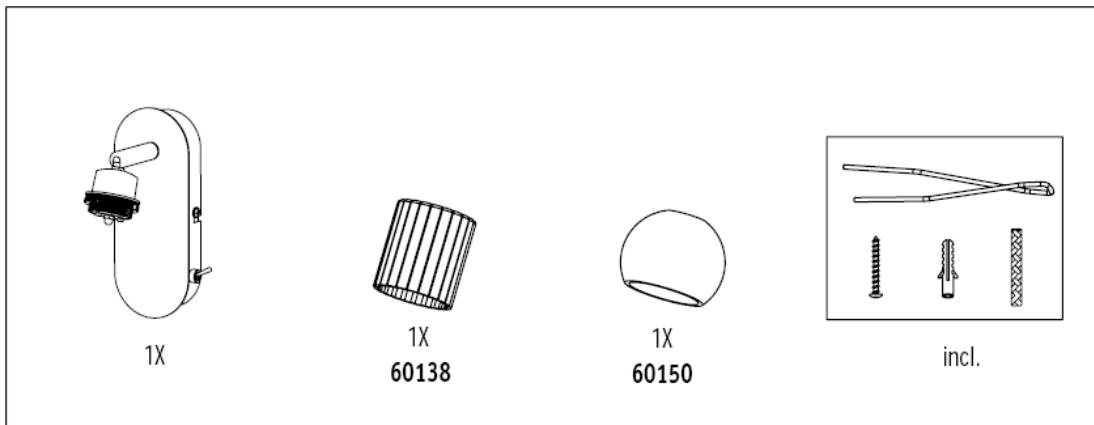



0,1,2,4,6,7,8,9,11,
15,18,20,22,25,27



Info Hotline



+49 (0) 5041 998 389

Mon.-Do. 7⁰⁰-20⁰⁰

Fr. 7⁰⁰-17⁰⁰



Paulmann Licht GmbH
31832 Springe / Germany
www.paulmann.com

Art.-Nr.:
60138
60150

(+MA 173)

PDG 04/11

E1

Safety Instructions
Nr. 0,1

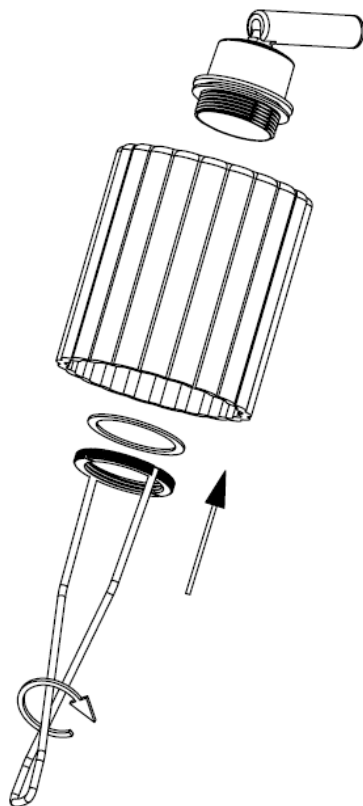

E2

Safety Instructions
Nr. 0,1

