

## Safety Instructions



0,1,2,3,4,7,8,10,11,12,  
15,16,17,19,20,21,22,  
23,25,26,27,28

 Info Hotline

+49 (0) 5041 998 389

Mon.-Do. 7<sup>00</sup>-20<sup>00</sup>

Fr. 7<sup>00</sup>-17<sup>00</sup>



Paulmann Licht GmbH  
31832 Springe / Germany  
www.paulmann.com

Art.-Nr.:

994.59

994.60





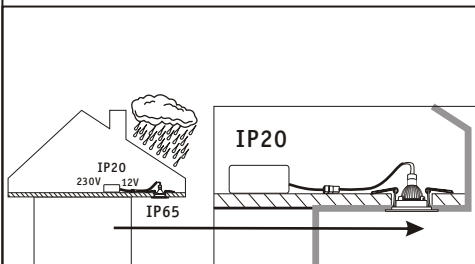
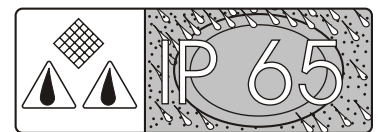
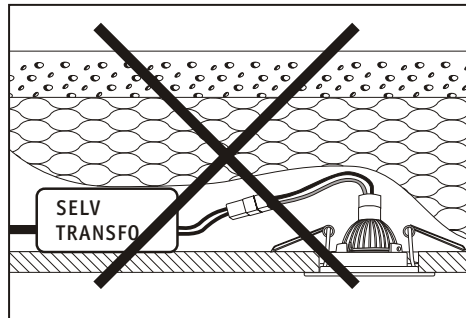
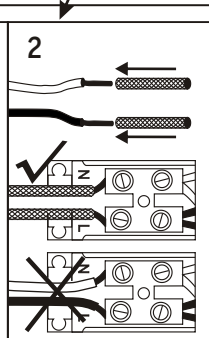
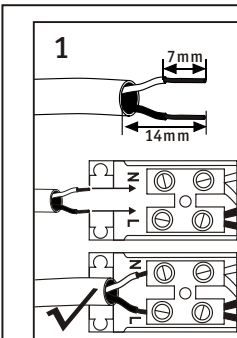
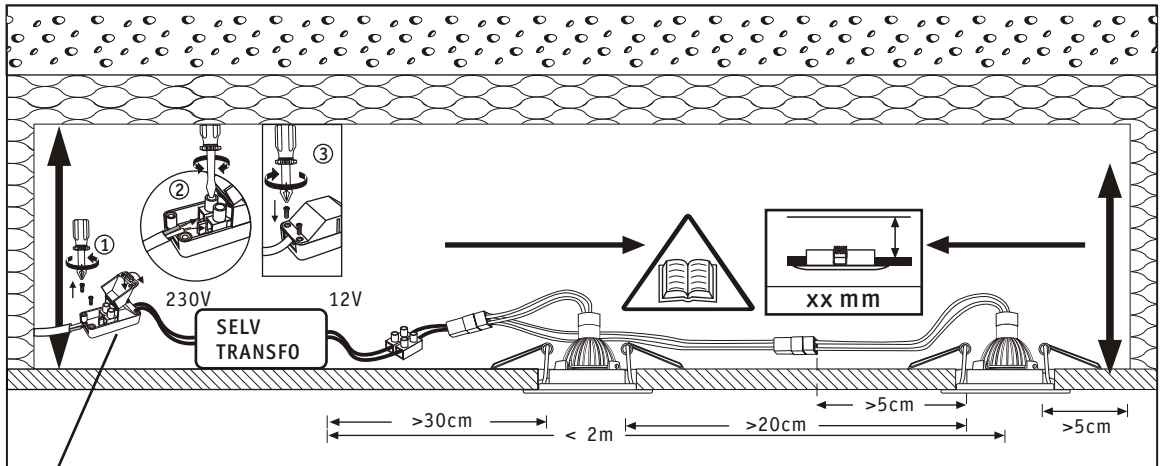
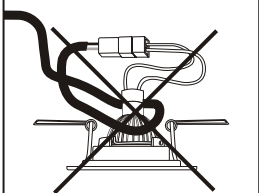
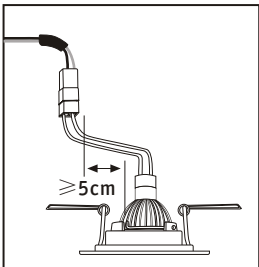
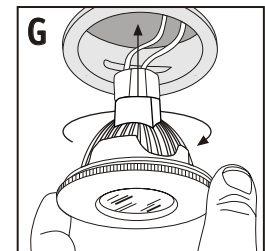
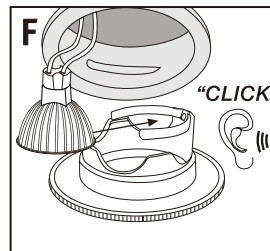
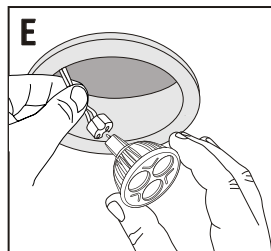
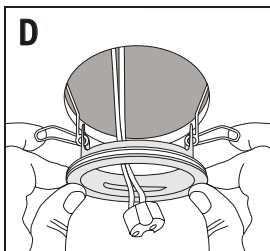
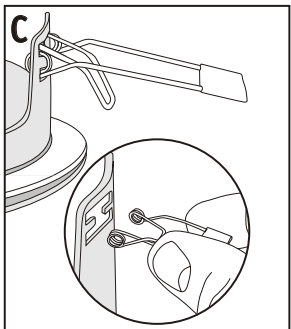
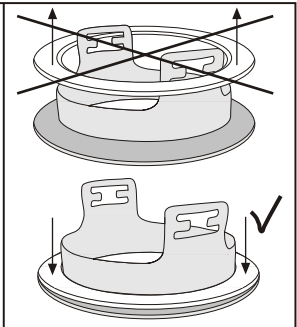
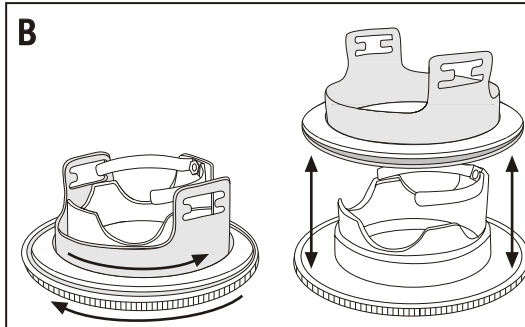
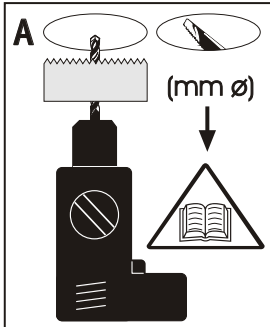
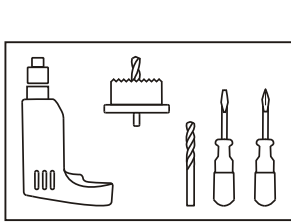

994.61

995.33

(+MA 173)

PBO 10 / 09



					
Coolbeam					
[mm]	[m]	[mmø]	[mm]	[cm]	[mm]
51	0.5	75	80	≥20	5-20