

Safety Instructions



0, 1, 2, 4, 6, 7, 8, 9, 11,
15, 22, 27



Info Hotline



+49 (0) 5041 998 389

Mon.-Do. 7:00 - 20:00

Fr. 7:00 - 17:00

Paulmann Licht GmbH
31832 Springe / Germany
www.paulmann.com

Art.-Nr.:
603.54

(+MA 173)

PUP 12/14

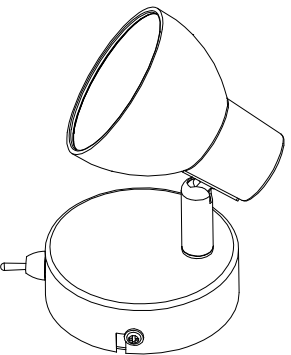

incl.

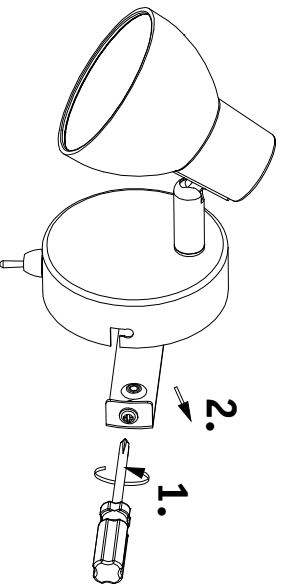
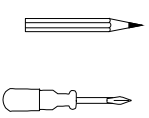
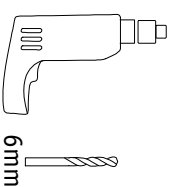
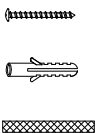

B

Safety Instructions

PNr. 0,1,2

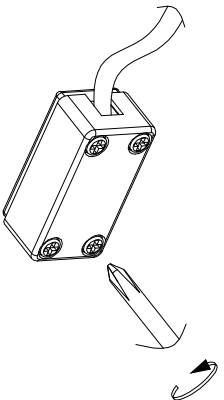
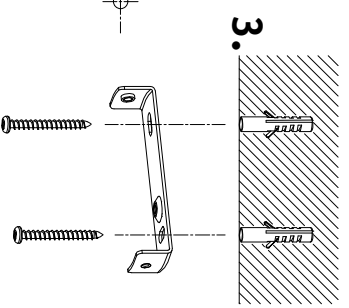
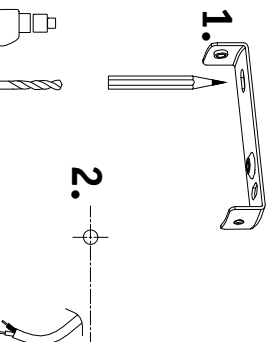

D

Safety Instructions

PNr. 0,1,4

