



Safety Instructions



0, 1, 2, 3, 4, 6, 7, 8, 9, 11,
15, 18, 20, 22, 25, 26, 27



+49 (0) 5041 998 389

Mon. - Do. 7⁰⁰ - 20⁰⁰

Fr. 7⁰⁰ - 17⁰⁰



Paulmann Licht GmbH
31832 Springe / Germany
www.paulmann.com

Art.-Nr.:
66035

(+MA 173)

PEA 08/09

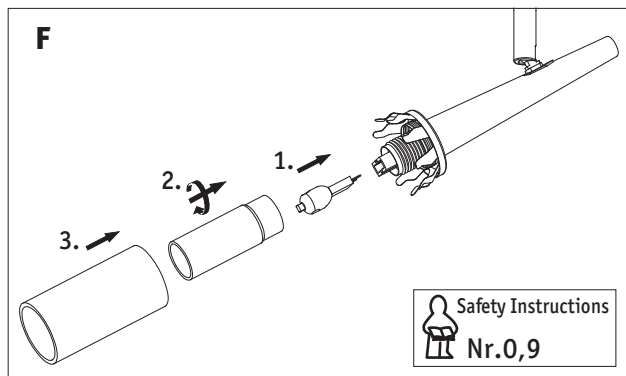
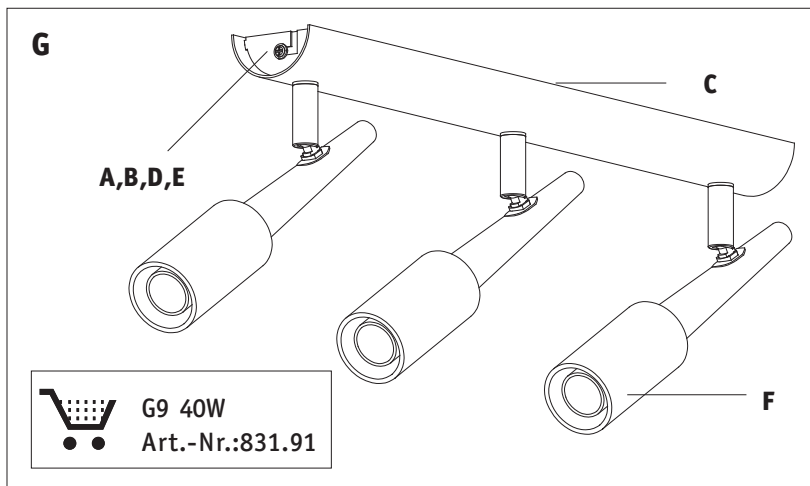
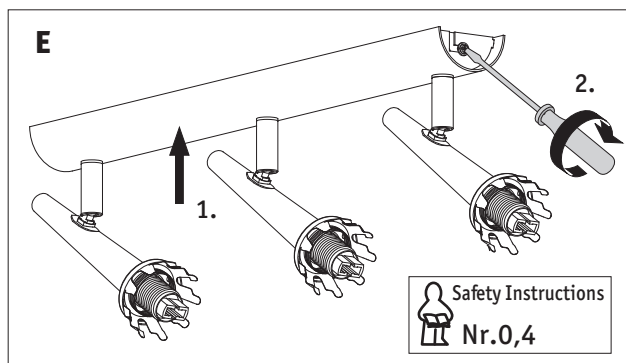
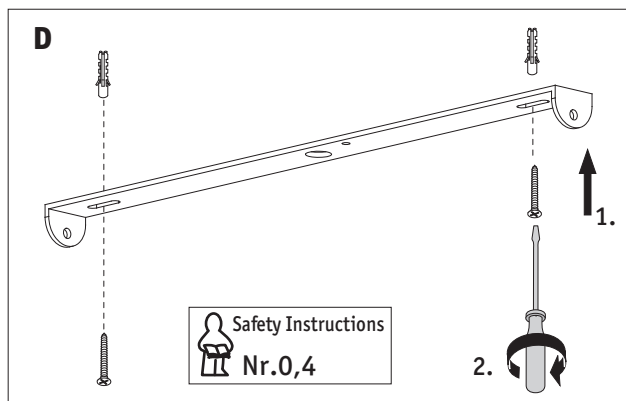
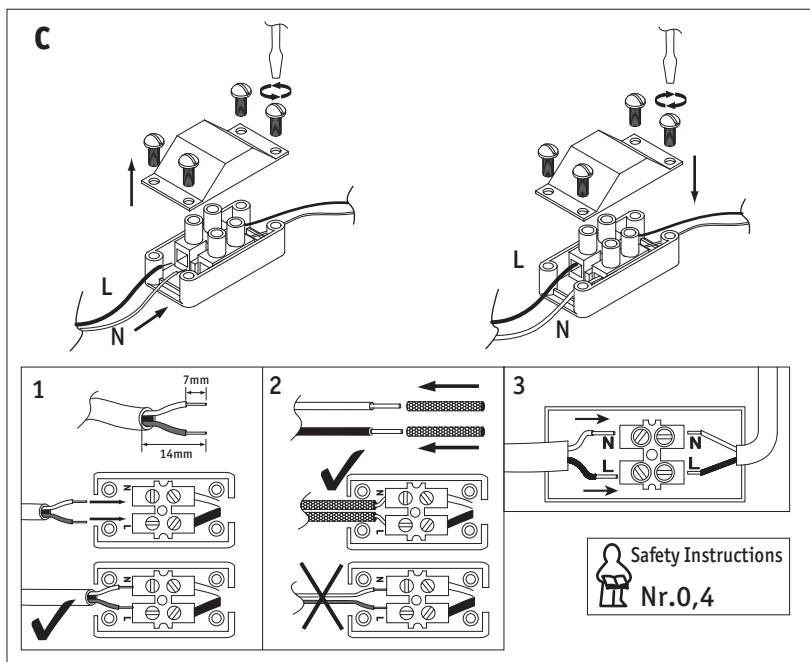
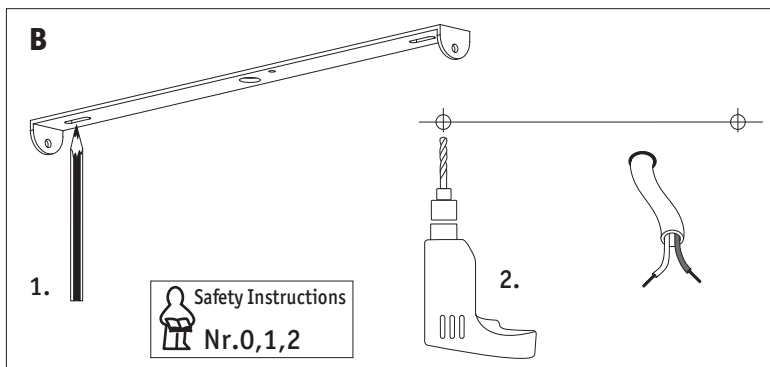
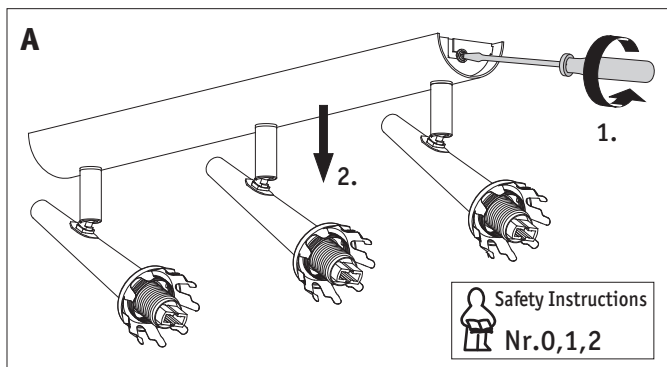
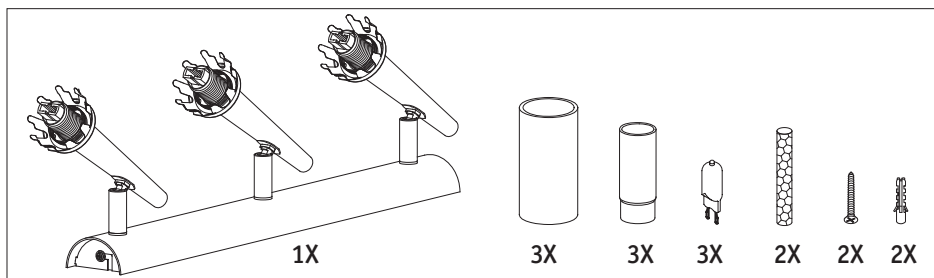

G9 40W
Art.-Nr.:831.91



Safety Instructions
Nr.0,9