

## Safety Instructions



0, 1, 2, 4, 6, 7, 8, 9, 11, 15,  
22, 25, 27



Info Hotline

+49 (0) 5041 998 389

Mon. - Do. 7<sup>00</sup> - 20<sup>00</sup>

Fr. 7<sup>00</sup> - 17<sup>00</sup>

Paulmann Licht GmbH  
31832 Springe / Germany  
www.paulmann.com

Art.-Nr.:

**70126**

(+MA 173)

PSA 12/10

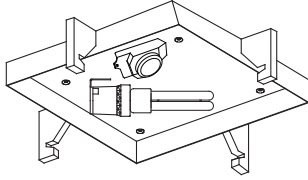

4x



4x



1x

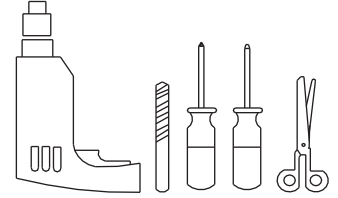

**A**

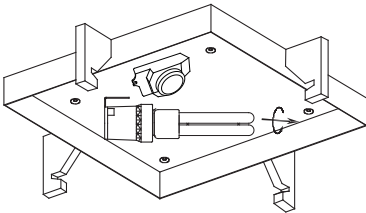

**B**

Safety Instructions  
Nr.0,1,2

1.

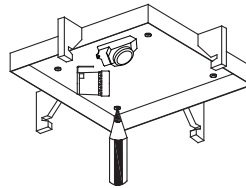

2.

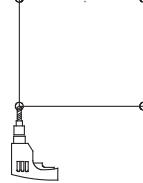

**C**

1.

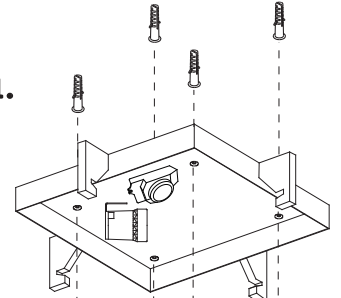

2.

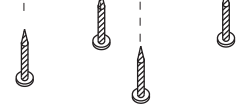

**D**

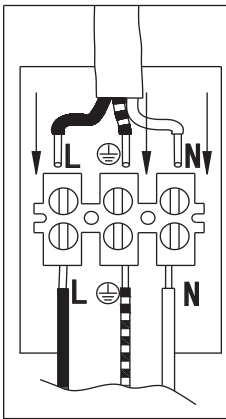

**E**

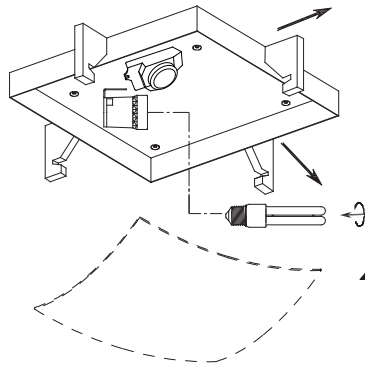

**F**

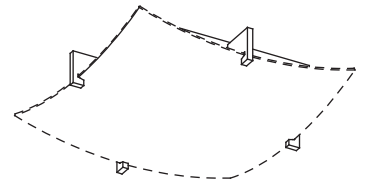

Art.No.  
15W E27 882.15

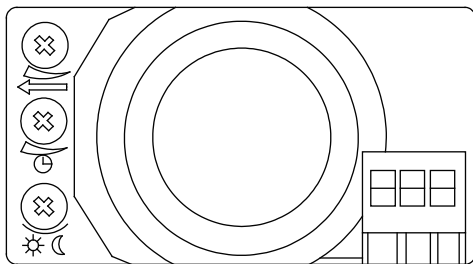

N L L

