



Safety Instructions



0, 1, 2, 4, 6, 7, 8, 9, 11
15, 22, 25, 27



Info Hotline +49(0)5041 998 389

Mon.-Do. 7⁰⁰-20⁰⁰
Fr. 7⁰⁰-17⁰⁰

paulmann Licht GmbH
31832 Springe / Germany
www.paulmann.com

Art.Nr.:
70169

(+MA 173)
PLK 04/10

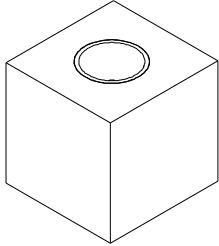

incl

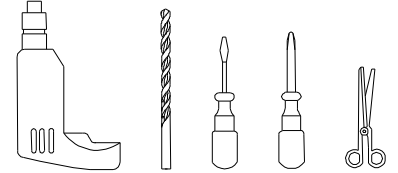
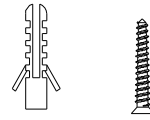

6mm

A

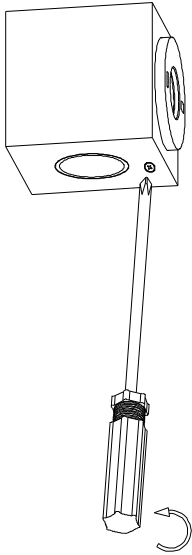

B

Safety Instructions
Nr. 0, 1, 2

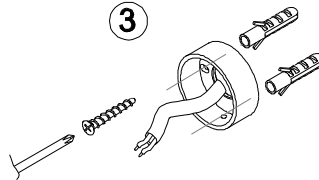
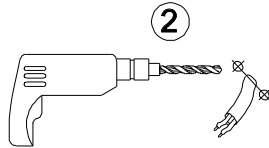
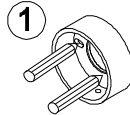

C

Safety Instructions
Nr. 0, 1, 4

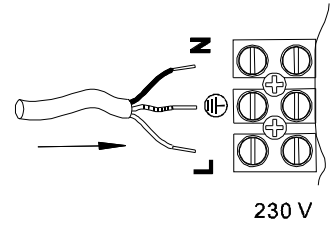
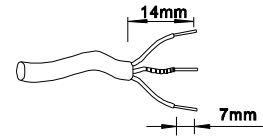

230 V

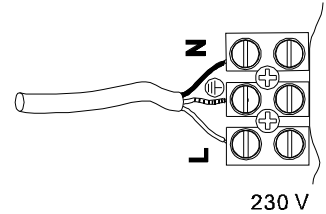

230 V

D

Safety Instructions
Nr. 0, 1

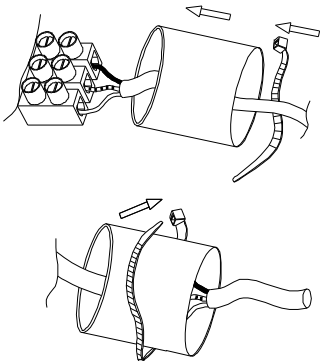

E

Safety Instructions
Nr. 0, 1

