



5, 6, 7, 8, 11, 15, 22, 26, 27, 28



Info Hotline 

**+49 (0) 5041 998 389**

Mon. - Do. 7<sup>00</sup> - 20<sup>00</sup>

Fr. 7<sup>00</sup> - 17<sup>00</sup>

Paulmann Licht GmbH  
31832 Springe / Germany  
www.paulmann.com

Art.-Nr.:  
**701.79**

(+MA 173)

PCI 05/10

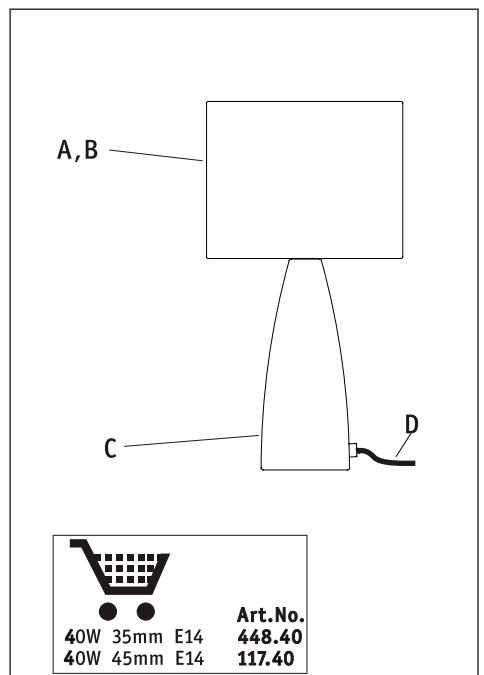
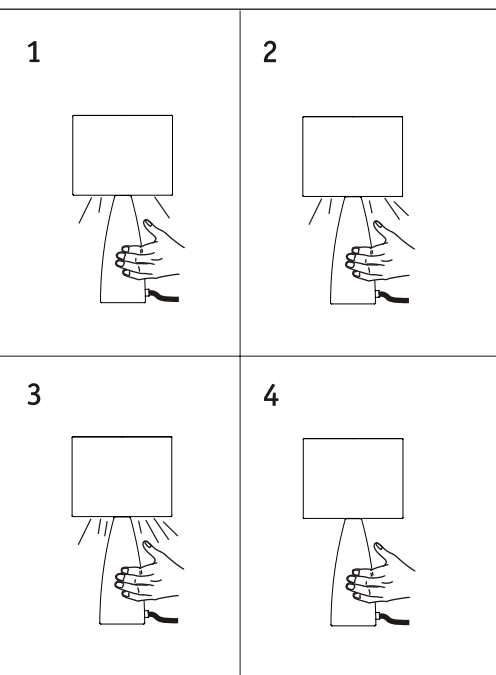
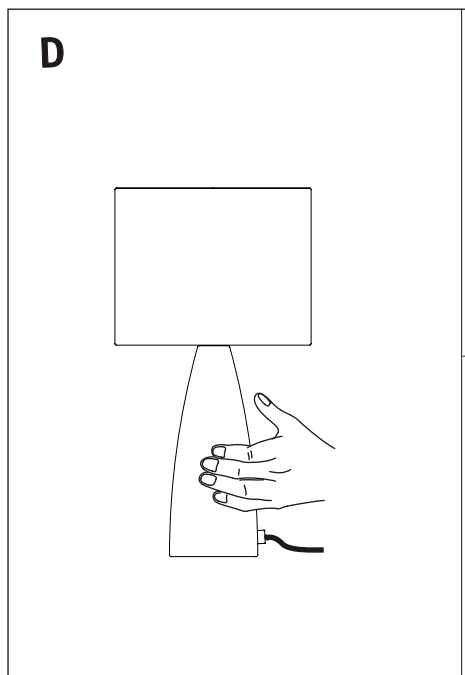
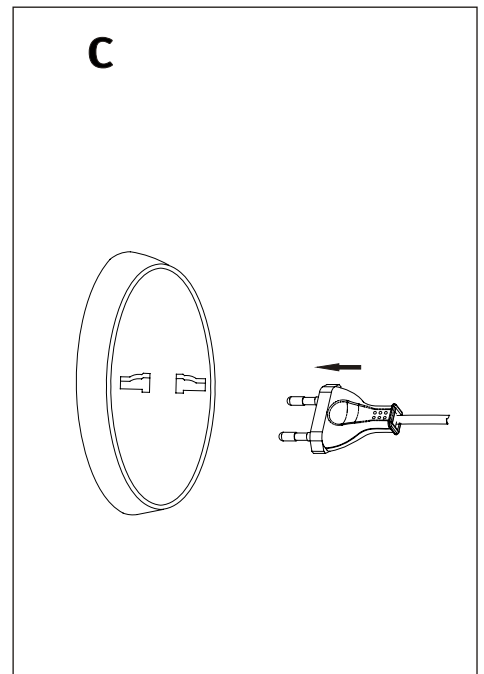
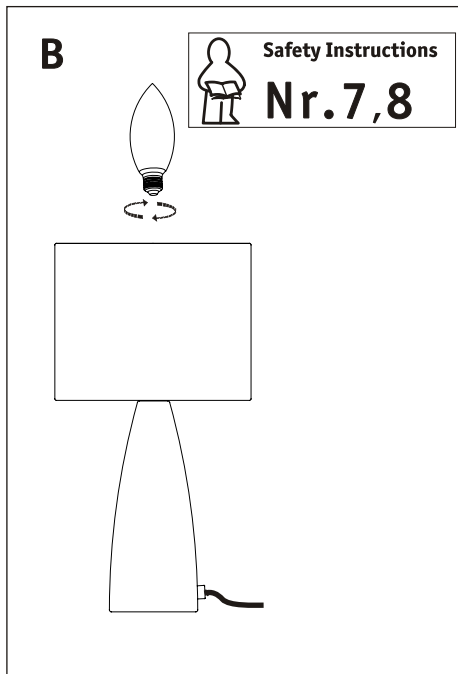
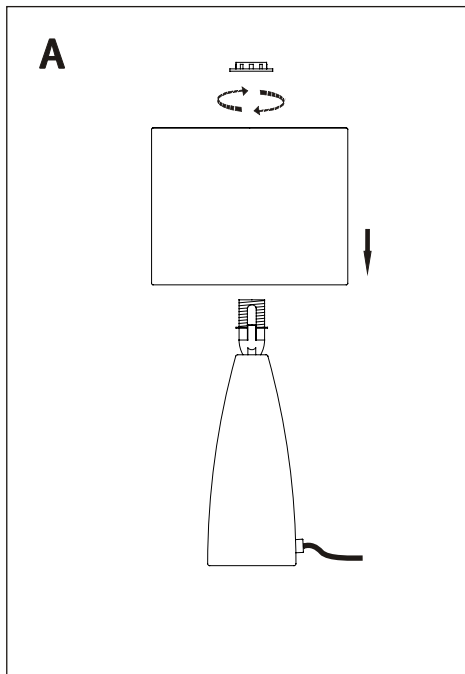
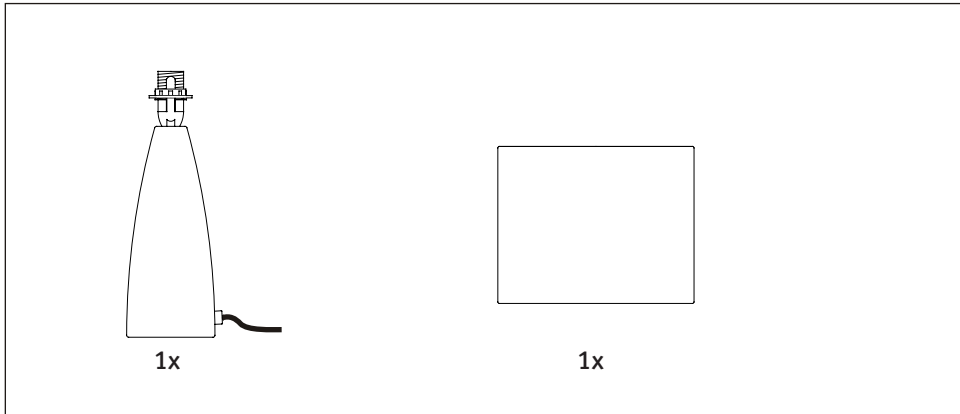

	<b>Art.No.</b>
40W 35mm E14	<b>448.40</b>
40W 45mm E14	<b>117.40</b>