

794.09
(+MA173)

Paulmann

SAFETY INSTRUCTIONS

0, 6, 11, 13, 15, 22, 28



PAULMANN LICHT GmbH
Quezing Feld 2 · D-31832 Springe
www.paulmann.com
☎ +49(0)5041 998 389

7^h-20^h
Mon.-Fri.

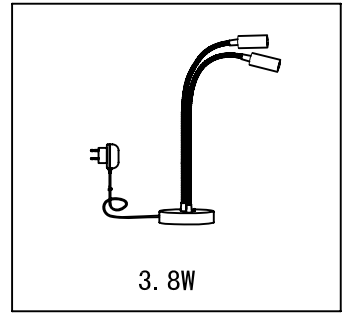
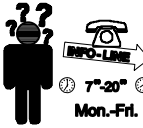

A

