

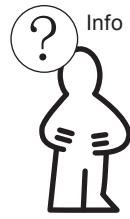

Safety Instructions



1, 2, 3, 4, 5, 6, 7,
9, 11, 12, 13, 14, 15,
16, 17, 18, 19, 21, 22,
23, 25, 28, 30, 31, 34,



Info Hotline

+49 (0) 5041 998 389

Mon.-Do. 7⁰⁰-20⁰⁰

Fr. 7⁰⁰-17⁰⁰

Paulmann Licht GmbH
31832 Springe/ Germany
www.paulmann.com

Art.-Nr.:

977.51

(+MA 197)

PDG 08/09

Safety Instructions
Nr. 13, 15, 16

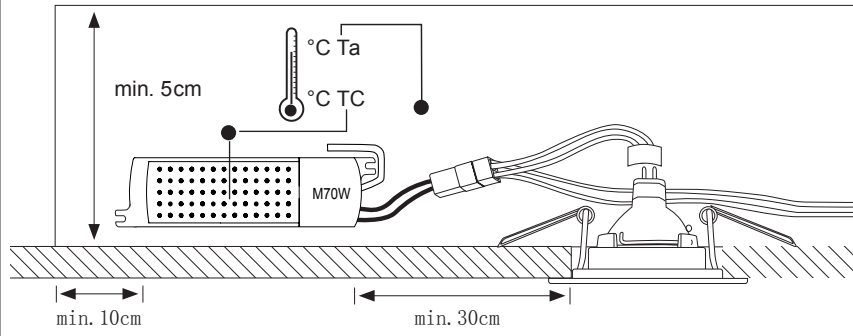

Safety Instructions
Nr. 14, 19, 22

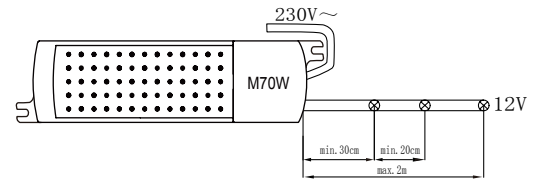

Safety Instructions
Nr. 12

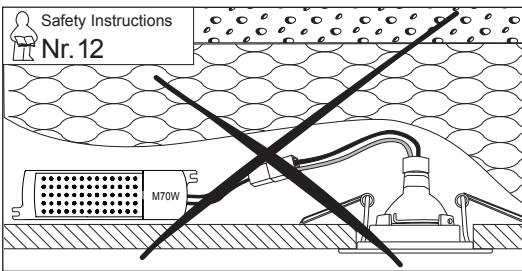

Safety Instructions
Nr. 21

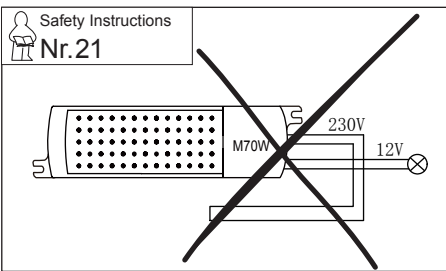

Safety Instructions
Nr. 23

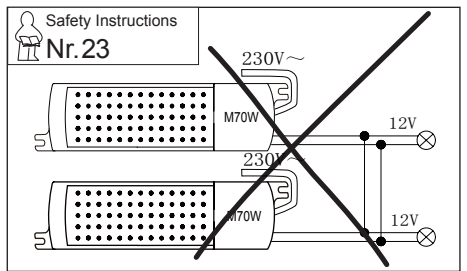

Transfo Mipro 70VA



Safety Instructions
Nr. 28a/b

Ta: -20...+50°C



Safety Instructions
Nr. 28a

TC: +80°C

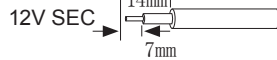
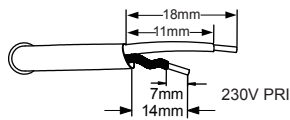

min. H03VVH2-F 0.75mm² × 2

- H03VVH2-F } 2x
- H05VVH2-F } 0.75mm²

