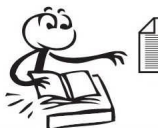

987.55
(+MA 230)

Paulmann

 **Safety Instructions**
0, 1, 2, 9, 10, 15, 16, 17,
19, 21, 25, 26, 28,

 **Paulmann Licht GmbH**
Quezinger Feld 2
D-31832 Springe
www.paulmann.com
☎ +49 (0) 5041 998 389
Mon.-Th. ☎ 7⁰⁰-20⁰⁰
Fr. ☎ 7⁰⁰-17⁰⁰

Art. No. 987. 55

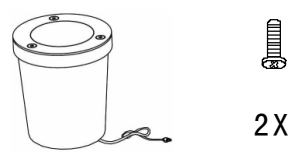

2X

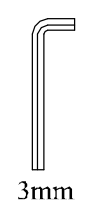

3mm

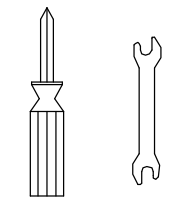

A

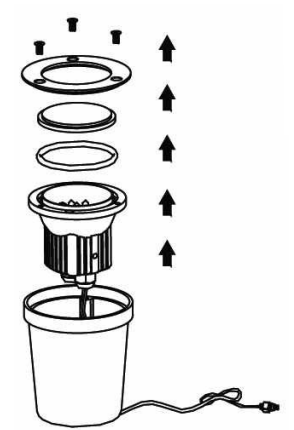

B



C

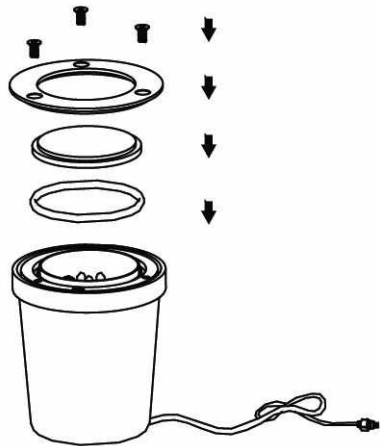

D

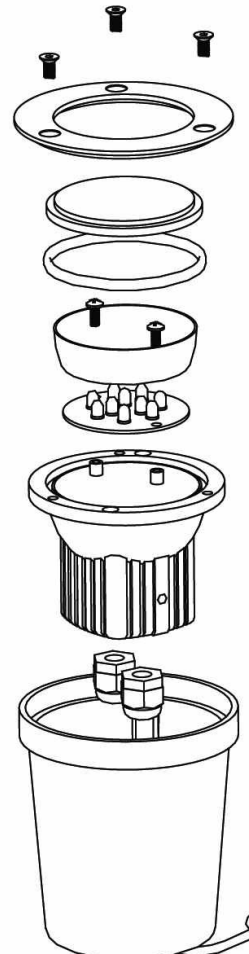
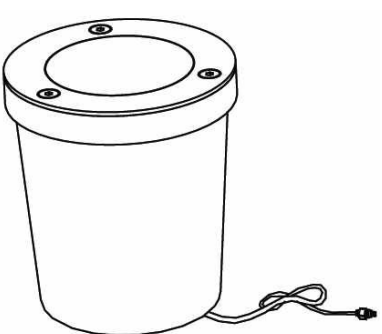

12V~ 50Hz