

Safety Instructions



0,1,4,7,8,9,11,15,
17,20,22



Info Hotline

+49 (0) 5041 998 389





Mon. - Do. 7⁰⁰ - 20⁰⁰

Fr. 7⁰⁰ - 17⁰⁰

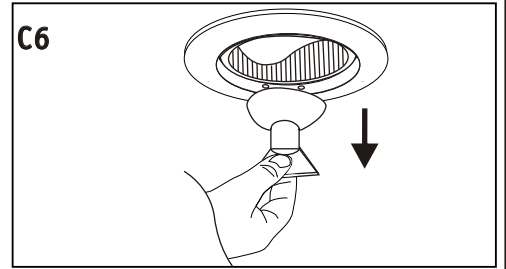
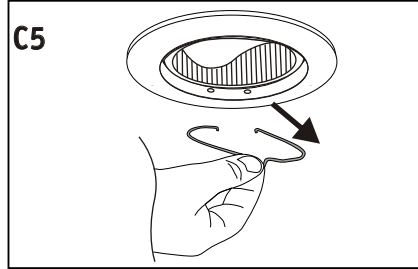
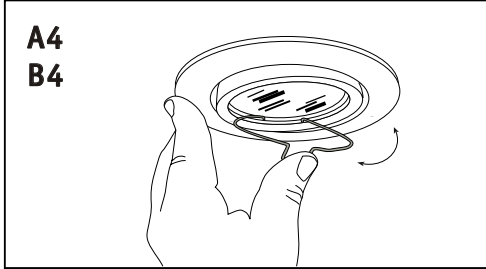
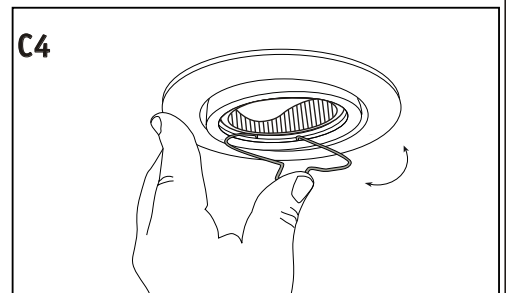
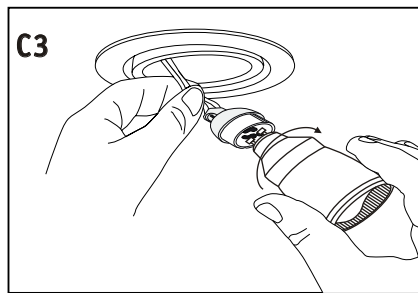
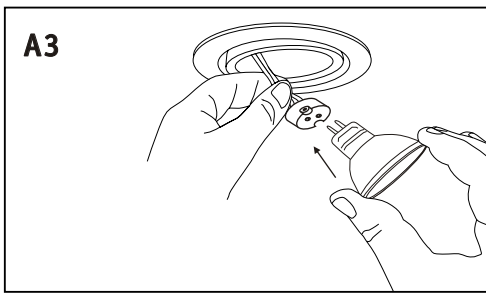
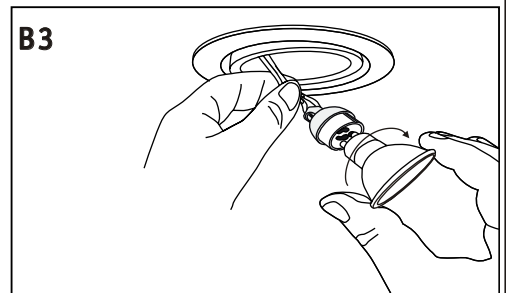
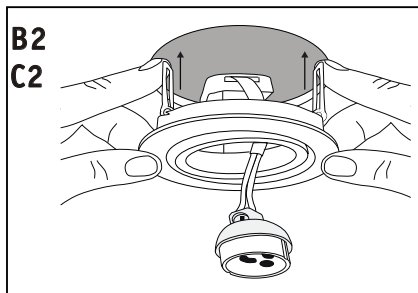
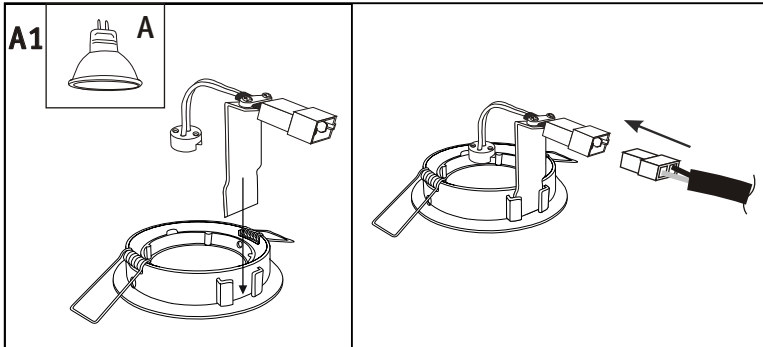
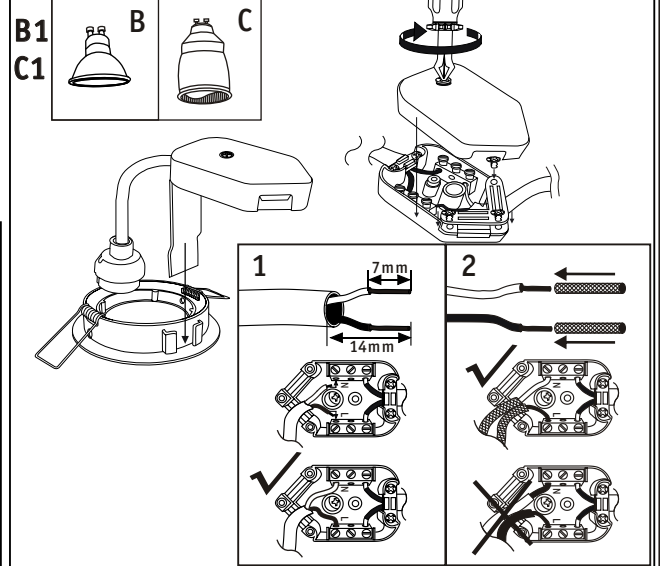
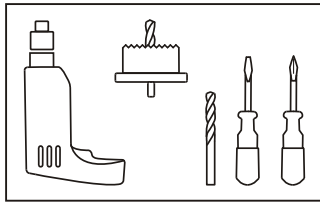
Paulmann Licht GmbH
31832 Springe / Germany
www.paulmann.com

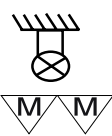
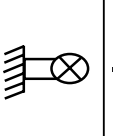
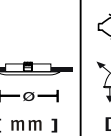
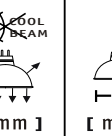
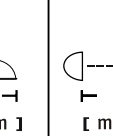
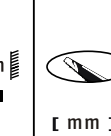
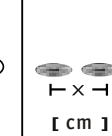
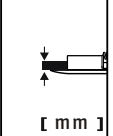
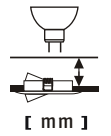
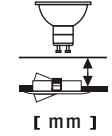
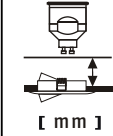
Art.-Nr.:
997.38/
39/40/41/
42/43/44/
45/49/54/
55/56
(+MA 173)
PBO 10/09



											
[mm]	[mm]	[mm]	[mm]	[m]	[mm]	[cm]	[mm]	[mm]	[mm]	[mm]	
		79	50	51	0.5	70	≥ 20	5-20	≥ 60	≥ 90	≥ 110
		83	50	51	0.5	68	≥ 20	5-20	≥ 60	≥ 90	≥ 110