



Safety Instructions



0,1,2,3,4,6,10,11,15,
16,17,21,22



Info Hotline



+49 (0) 5041 998 389

Mon. - Do. 7⁰⁰ - 20⁰⁰

Fr. 7⁰⁰ - 17⁰⁰

Paulmann Licht GmbH
31832 Springe / Germany
www.paulmann.com

Art.-Nr.:

998.10
998.11

(+MA 173)

PSU 11/09

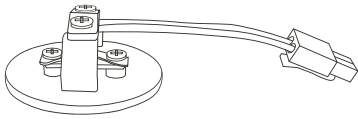

10x

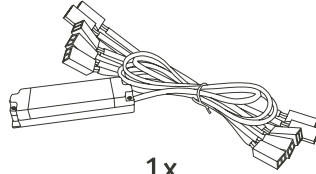

1x

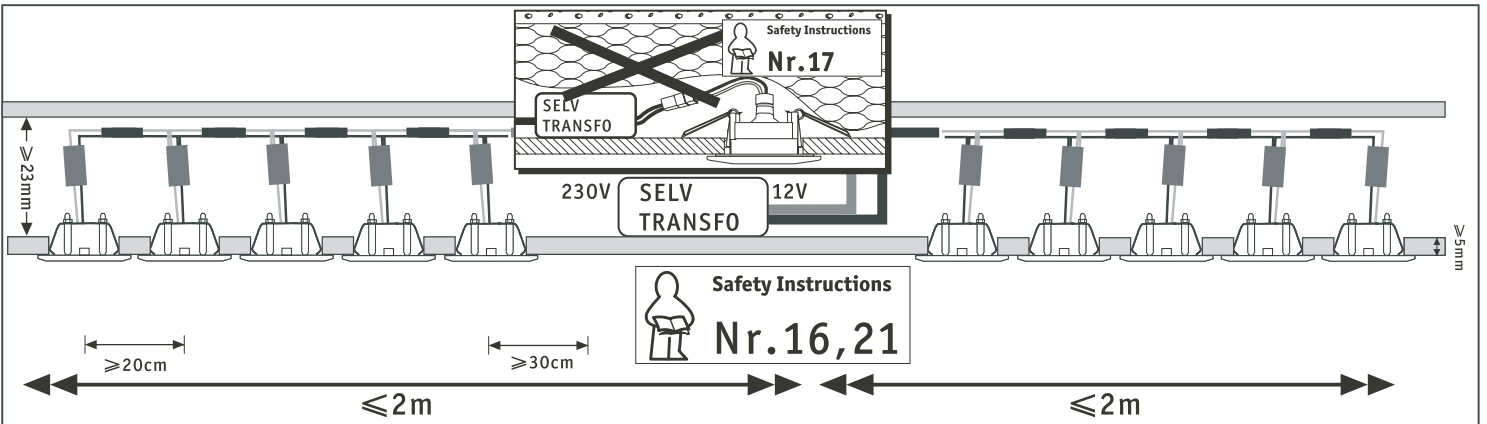
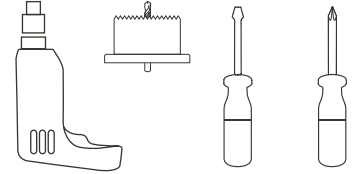

A



($\varnothing 23\text{mm}$)

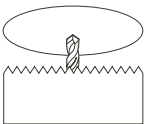

Safety Instructions

Nr. 0, 2

B



Safety Instructions

Nr. 3, 4

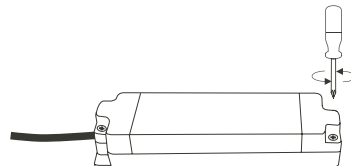

14mm

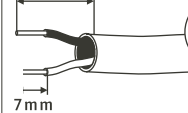

7mm

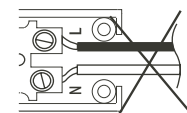
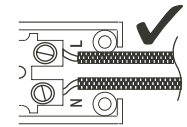
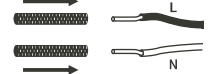
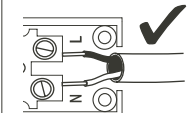
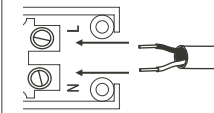

C

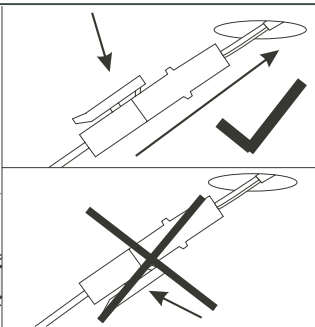
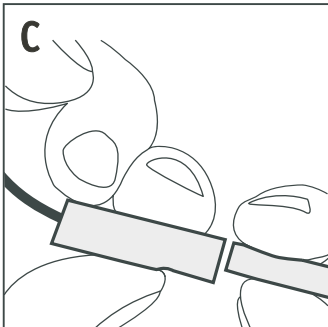

D

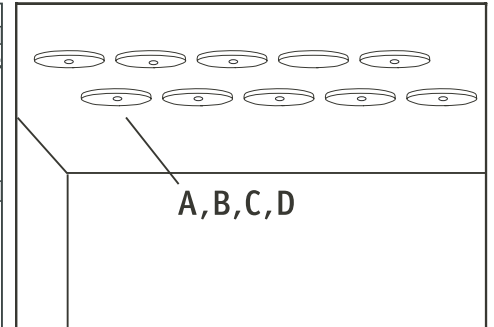
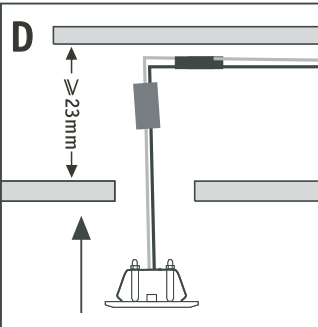

A, B, C, D

