



Safety Instructions



0, 1, 2, 3, 4, 6, 7, 8, 9, 11, 15,
20, 22, 25, 26, 27, 28



Info Hotline

+49 (0) 5041 998 389

Mon. - Do. 7⁰⁰ - 20⁰⁰

Fr. 7⁰⁰ - 17⁰⁰



Paulmann Licht GmbH
31832 Springe / Germany
www.paulmann.com

Art.-Nr.:
99821

(+MA 173)

PEA 09/09

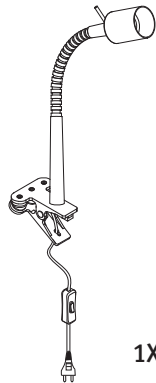

1X



1X

A

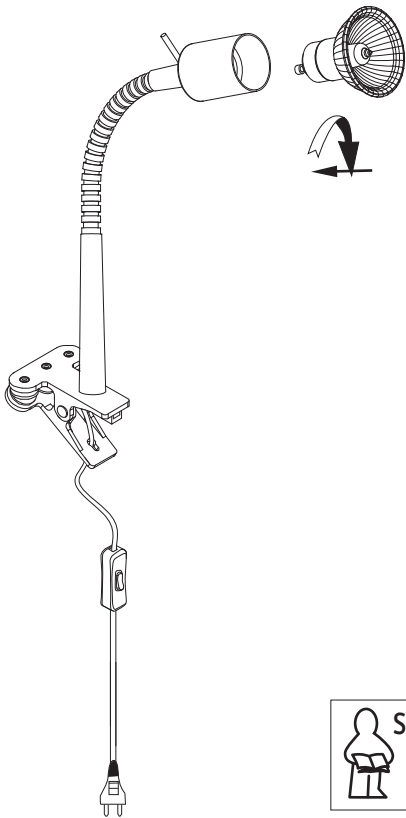

Safety Instructions

Nr.9

C

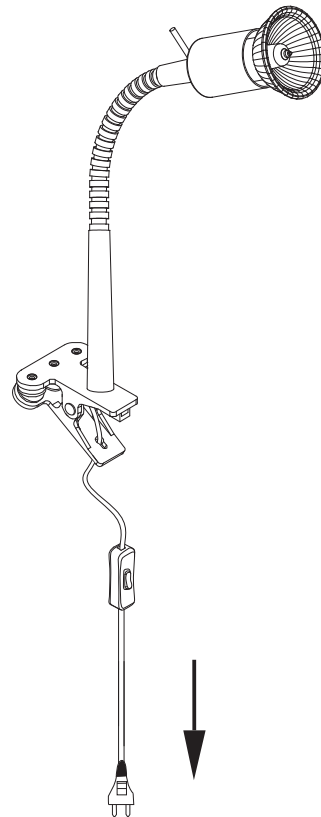

B

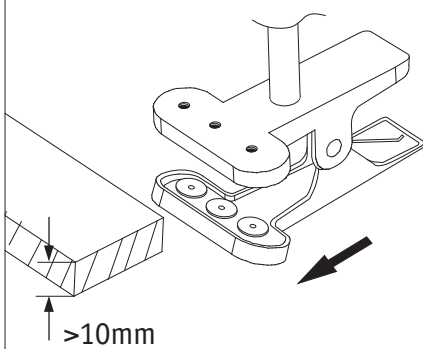

>10mm

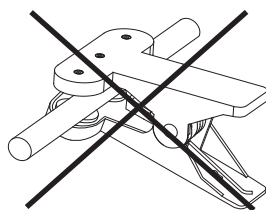
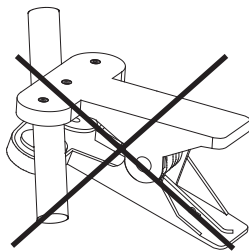

D

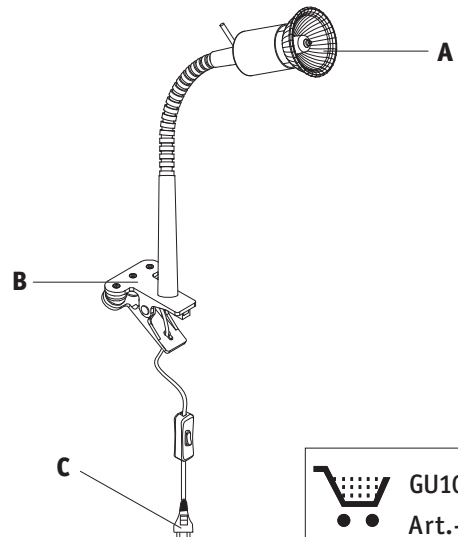

GU10 35W
Art.-Nr.:836.07